

VOLTAGE RANGE: 800 - 1000V

CURRENT: 4.0 A

Features

- Diffused Junction
- Low Forward Voltage Drop
- High Current Capability
- High Reliability
- High Surge Current Capability

Mechanical Data

- Case: DO-201AD, Molded Plastic
- Terminals: Plated Leads Solderable per MIL-STD-202, Method 208
- Polarity: Cathode Band
- Weight: 1.2 grams (approx.)
- Mounting Position: Any
- Marking: Type Number

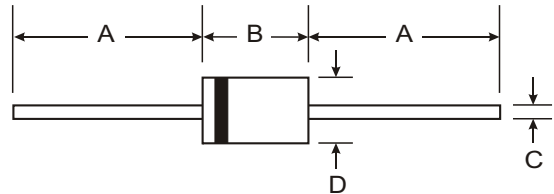
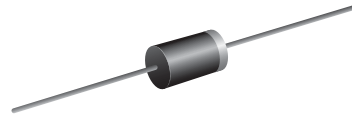

DO-201AD		
Dim	Min	Max
A	25.40	—
B	8.50	9.53
C	0.96	1.06
D	4.80	5.21
All Dimensions in mm		

Maximum Ratings and Electrical Characteristics @ $T_A=25^\circ\text{C}$ unless otherwise specified

Single Phase, half wave, 60Hz, resistive or inductive load. For capacitive load, derate current by 20%.

Characteristic	Symbol	MUR480	MUR4100	Unit
Peak Repetitive Reverse Voltage	VRRM	800	1000	V
Working Peak Reverse Voltage	VRWM			
DC Blocking Voltage	VR			
RMS Reverse Voltage	VR(RMS)	560	700	V
Average Rectified Output Current (Note 1) @ $T_A = 55^\circ\text{C}$	IO	4.0		A
Non-Repetitive Peak Forward Surge Current 8.3ms Single half sine-wave superimposed on rated load (JEDEC Method)	IFSM	150		A
Forward Voltage @ $I_F = 5.0\text{A}$	VFM	1.7		V
Peak Reverse Current @ $T_A = 25^\circ\text{C}$ At Rated DC Blocking Voltage @ $T_A = 100^\circ\text{C}$	IRM	10	100	μA
Reverse Recovery Time (Note 2)	trr	75		nS
Typical Junction Capacitance (Note 3)	Cj	50		pF
Operating Temperature Range	Tj	-65 to +125		$^\circ\text{C}$
Storage Temperature Range	TSTG	-65 to +150		$^\circ\text{C}$

- Note: 1. Leads maintained at ambient temperature at a distance of 9.5mm from the case
 2. Measured with $I_F = 0.5\text{A}$, $I_R = 1.0\text{A}$, $I_{RR} = 0.25\text{A}$. See figure 5.
 3. Measured at 1.0 MHz and applied reverse voltage of 4.0V D.C.

FIG. 1-TEST CIRCUIT DIAGRAM AND REVERSE RECOVERY TIME CHARACTERISTIC

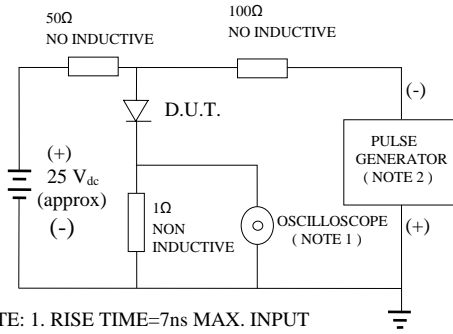

NOTE: 1. RISE TIME=7ns MAX. INPUT IMPEDANCE=1 MOhms 22PF
 2. RISE TIME =10ns MAX. SOURCE IMPEDANCE=50 OHMS

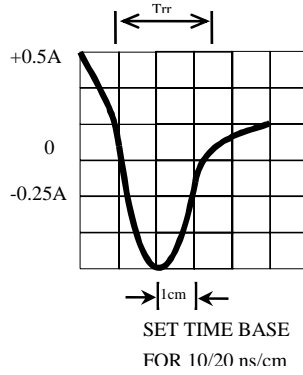

FIG. 2-TYPICAL FORWARD CURRENT DERATING CURVE

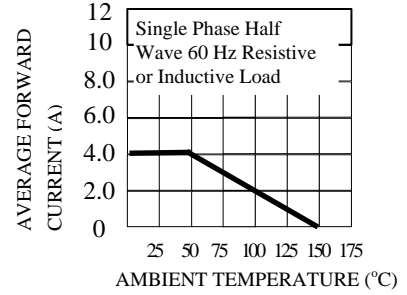

FIG. 3-TYPICAL REVERSE CHARACTERISTICS

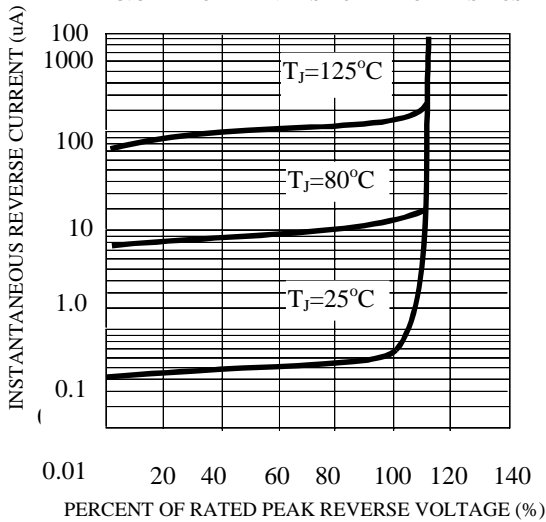

FIG. 4-TYPICAL INSTANTANEOUS FORWARD CHARACTERISTICS

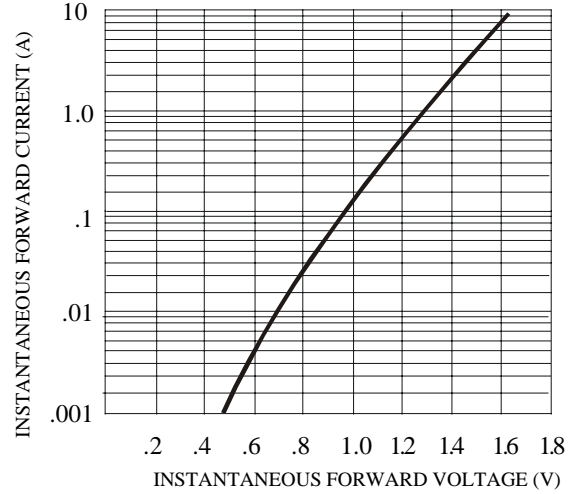

FIG. 5-MAXIMUM NON-REPETITIVE FORWARD SURGE CURRENT

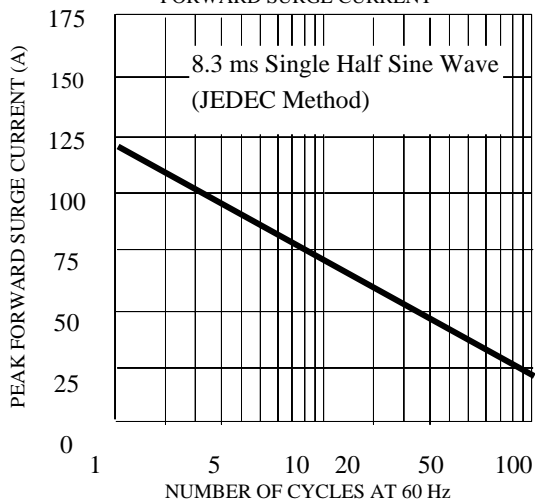

FIG. 6-TYPICAL JUNCTION CAPACITANCE

