

Features

- Small SOD-323 Package
- Unidirectional Configurations
- Peak Power Dissipation 250W @8 x 20 us Pulse
- Low Leakage
- Fast Response Time < 1 ns
- Protects One Power or I/O Port
- ESD Protection to IEC 61000-4-2 Level 4, 15KV(Air), 8KV(Contact)
- ESD Protection to IEC 61000-4-2 Level 4, 30A
- 16KV Human Body Model ESD Requirements
- RoHS Compliant in Lead-Free Versions

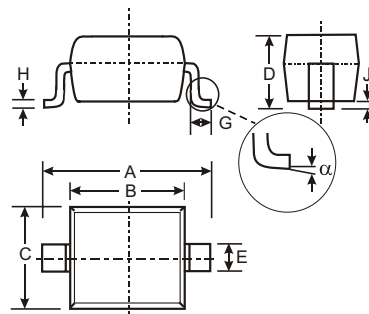
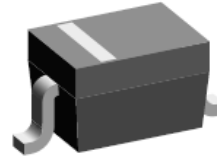

SOD-323		
Dim	Min	Max
A	2.30	2.70
B	1.60	1.80
C	1.20	1.40
D	1.05 Typical	
E	0.25	0.35
G	0.20	0.40
H	0.10	0.15
J	0.05 Typical	
α	0°	8°
All Dimensions in mm		

Mechanical Data

- Cell Phone Handsets and Accessories
- Microprocessor Based Equipment
- Personal Digital Assistant (PDA)
- Notebooks, Desktops, and Servers
- Portable Instrumentation
- Pagers Peripherals

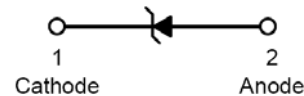

Absolute Maximum Ratings

Parameter	Symbol	Value	Units
Peak Power Dissipation (Note 1.) @ $T_L = 25^\circ\text{C}$	P_{PK}	250	W
IEC 61000-4-2 (ESD)	Air CONTACT	± 15	KV
		± 8.0	KV
IEC 61000-4-4 (EFT)		30	A
ESD Voltage Per Human Body Model	V_{PP}	16	KV
Storage Temperature Range	T_{STG}	-55 to 150	$^\circ\text{C}$
Operating Junction Temperature Range	T_J	-55 to 150	$^\circ\text{C}$

1. 8 X 20 us, non-repetitive



Electrical Characteristics

Ratings at 25°C ambient temperature unless otherwise specified.

Symbol	Parameter
I_{PP}	Maximum Reverse Peak Pulse Current
V_C	Clamping Voltage @ I_{PP}
V_{RWM}	Working Peak Reverse Voltage
I_R	Maximum Reverse Leakage Current @ V_{RWM}
I_T	Test Current
V_{BR}	Breakdown Voltage @ I_T
I_F	Forward Current
V_F	Forward Voltage @ I_F

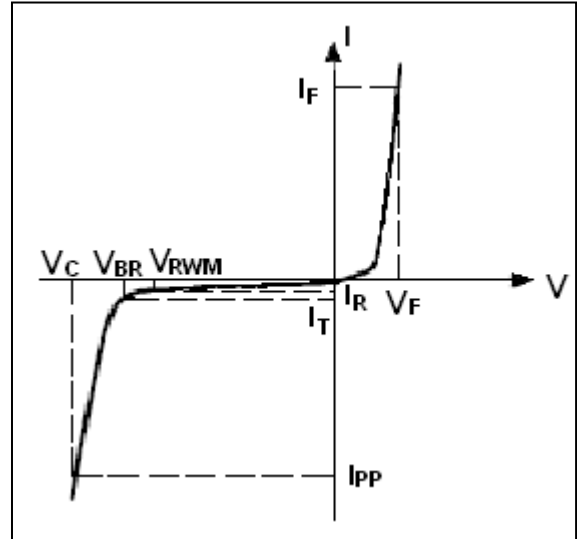

Electrical Characteristics Ratings at 25°C ambient temperature unless otherwise specified.

Device	V_{RWM} (V)	I_R (μ A) @ V_{RWM}	V_{BR} (V) @ I_T (Note 1)		I_T	V_C (V) @ $I_{PP}=5$ A*	V_C (V) @ Max I_{PP} *	I_{PP} (A)*	C@OV 1MHz (pF)
	Max	Max	Min	Max	mA	Typ	Max	Max	Typ
PESD03C	3.3	40	4.0	6.5	1.0	9.0	10.9	20	500
PESD05C	5.0	10	6.2	7.3	1.0	9.8	14.5	20	350
PESD12C	12	1.0	13.3	15.75	1.0	19	25	12	150

*Surge current waveform per Figure 1.

- V_{BR} is measured with a pulse test current I_T at an ambient temperature of 25°C.

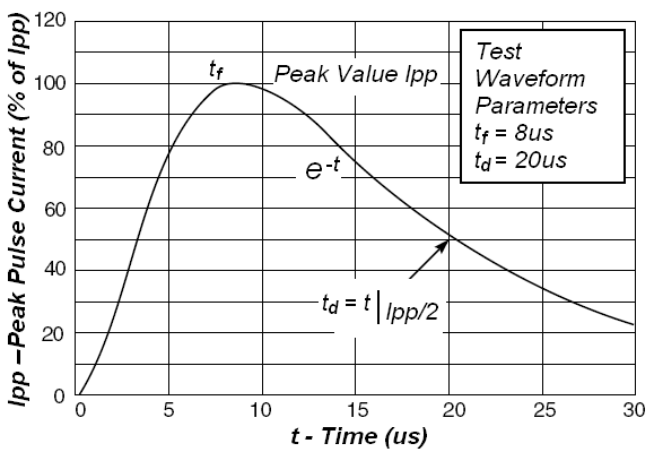

Fig1. Pulse Waveform

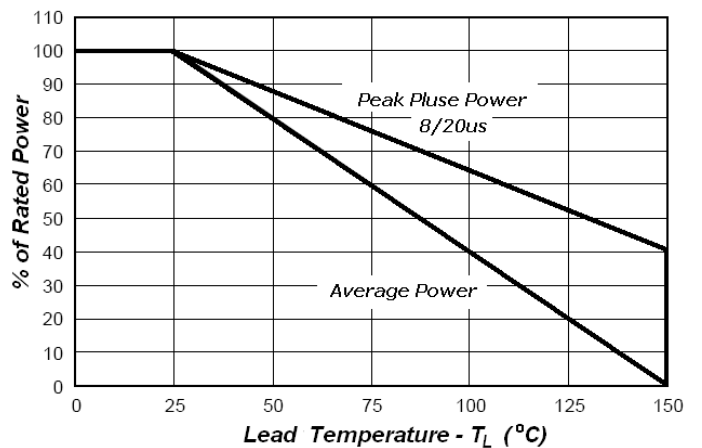

Fig2. Power Derating

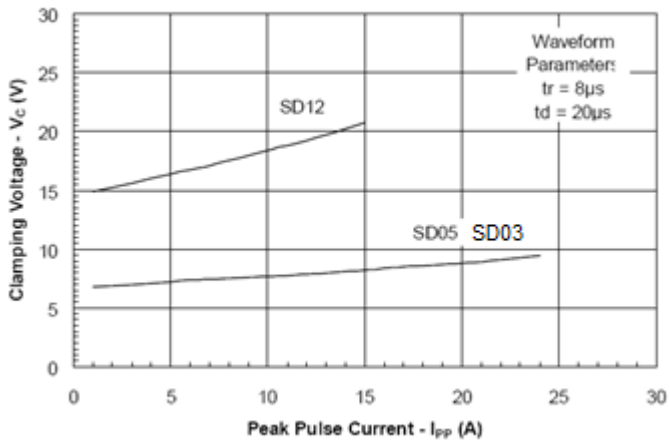

Fig3. Clamping Voltage vs. Peak Pulse Current

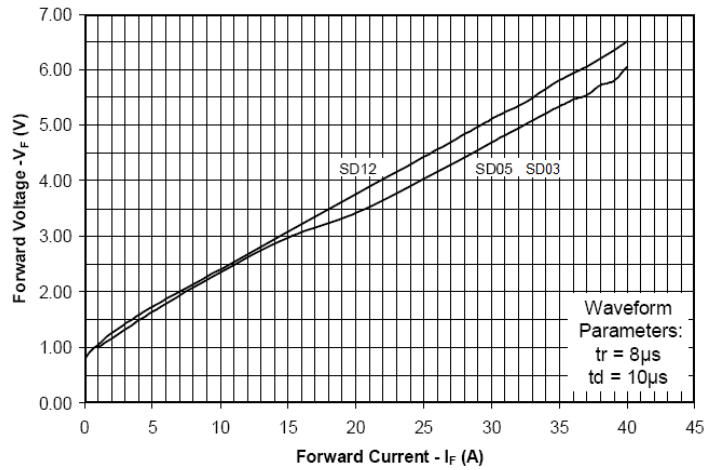

Fig4. Forward Voltage vs. Forward Current

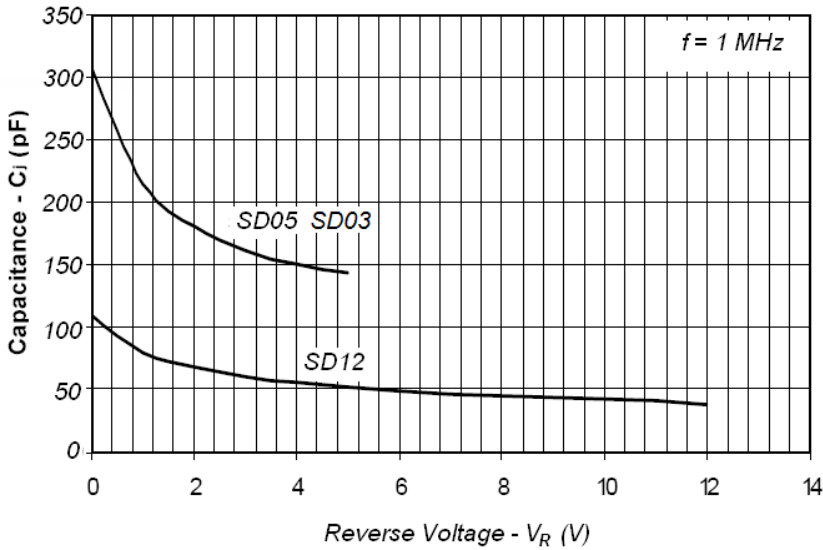

Fig5. Capacitance vs. Reverse Voltage